

The **P SERIES** automatic bollards are the top line products of PILOMAT range. The current models are the result of the development of more than 15 years of experience.



GENERAL FEATURES

- **hydraulic movement:** The most reliable technology for most intense use at all temperatures and weather conditions;
- **built-in hydraulic pump in the bollard:** This philosophy has many advantages, particularly in installations in locations with severe winter temperatures or when the installation requires a considerable distance (up to 80 metres) between the PILOMAT and the control unit;
- **patented system for the protection of handling:** to maximise the reliability of operations due to impact by vehicles on the cylinder that is put in motion;
- **wide range of optional configurations:** custom colours, flashing lights integrated into the head, intermittent sound signal, 220V solenoid valve (in case of power failure, the PILOMAT is lowered, releasing the gate), heat resistance installations in locations with harsh winter temperatures, UPS unit for operation in the temporary occurrence of power failure, equipment control, equipment accident prevention (see accessories and optional items).

RECOMMENDED USES

- Pedestrian Areas
- Private Car Parks – Parking Company
- Private Driveways – Driveway Businesses – Commercial Driveways

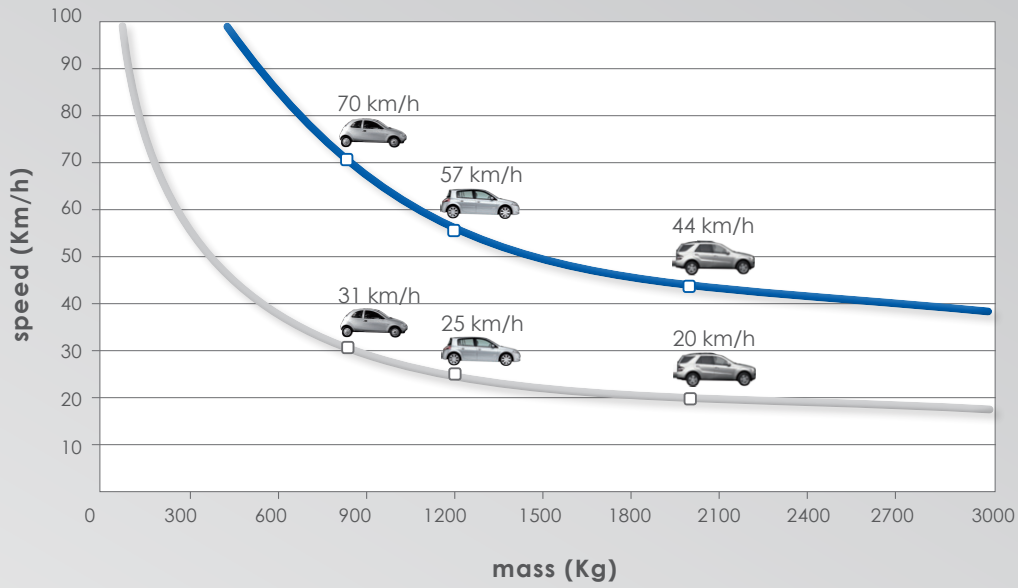
MOVING CYLINDER	FE 370 STEEL (IRON) – AISI 304 STAINLESS STEEL
MOVING CYLINDER NOMINAL DIAMETER	127 mm
MOVING CYLINDER HEIGHT	800 mm
MOVING CYLINDER FE 370 STEEL THICKNESS	6 mm
MOVING CYLINDER STAINLESS STEEL THICKNESS	AISI 304 :4 mm
MOVING CYLINDER FE 370 STEEL FINISH	POLYESTER POWDER PAINT – STANDARD GREY ANTHRACITE
MOVING CYLINDER STAINLESS STEEL FINISH	AS ABOVE, OR BRUSHED
REFLECTING ADHESIVE STRIP	YES - HEIGHT 23 mm
RISE SPEED	10 cm/sec
LOWERING SPEED	10 cm/sec(WITH RELEASE NO 220: 20 cm/sec)
MANUAL EMERGENCY LOWERING	YES (VERSION WITH RELEASE NO 220 = AUTOMATIC LOWERING)
SAFETY REVERSAL PRESSURE SWITCH	YES
CONNECTION LINE TO CONTROL UNIT	STANDARD 10 mt (MAXIMUM LENGTH: 80 mt)
HYDRAULIC PUMP	BUILT-INTO THE PILOMAT
GRADE OF PROTECTION	IP 67
TYPE OF USE	INTENSIVE - LIFE AVERAGE 2.000.000 MOVEMENTS - 2.000 MOVEMENTS/DAY
IMPACT RESISTANCE (WITHOUT DEFORMATION)	30.000 J
BREAKOUT RESISTANCE	150.000 J
OPERATING TEMPERATURE	- 40°C + 60°C (FOR LOW TEMPERATURES SEE HEATING RESISTANCE)
NOMINAL PILOMAT WEIGHT (WITHOUT PIT)	90 kg
NOMINAL WEIGHT OF STANDARD PIT, WITH COUNTER-FRAME AND BRACKETS	32 kg



BREAKOUT RESISTANCE 150.000 J

IMPACT RESISTANCE 30.000 J

800 Kg 1.200 Kg 2.000 Kg

MAIN DIMENSIONS

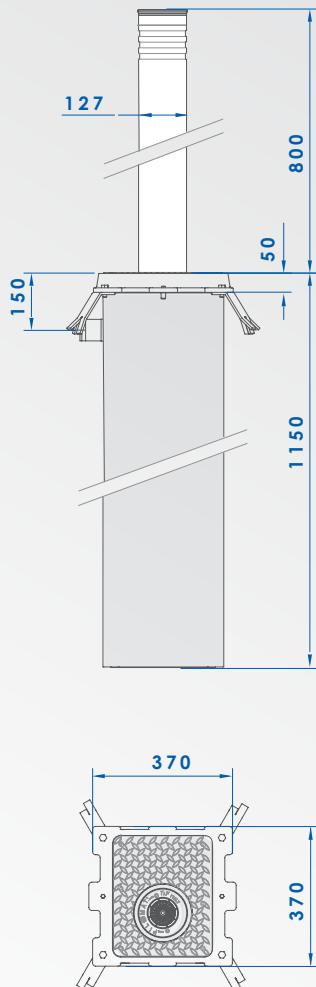

OPTIONAL ITEMS



INTEGRATED FLASHING LIGHT IN THE HEAD



RAL PAINTING ON REQUEST



ANONYMOUS HEAD

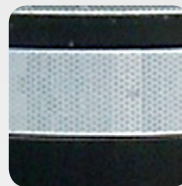

NEUTRAL REFRACTED STRIP

BUZZER ACOUSTIC SIGNAL DURING THE MOVEMENT

HYDRAULIC PUMP WITH BIODEGRADABLE OIL

CONNECTION LINE, UP TO 80 MT